

# HUMESMARTROBES

## INSTALLATION INSTRUCTIONS

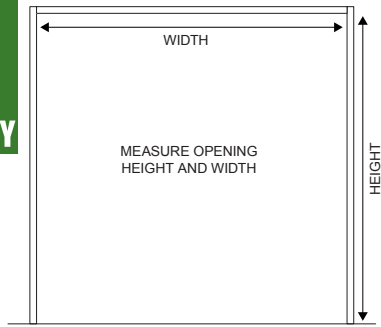

1. Measure stud opening for size. R□  
D R R R R□  
D G 3 3 I R M R E□  
5 I R R E L L N□  
I R R R I R P D L R□

2. Fix the Timber Stiles to the head and sill members as per diagram.

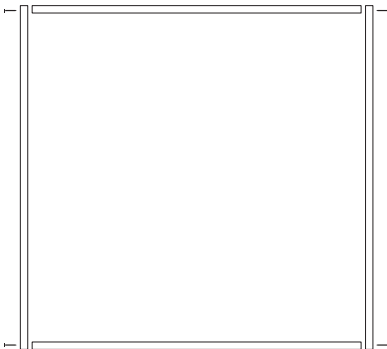

3. Place the assembled frame in the opening. Pack and fix to studs. Make sure frame is assembled square, plumb and level.

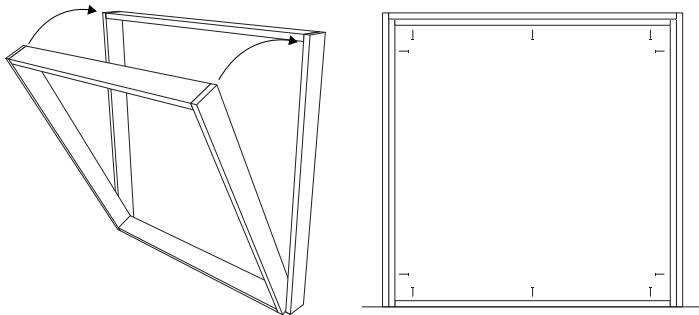

4. Fit the top and bottom track. Fix using track screws provided.

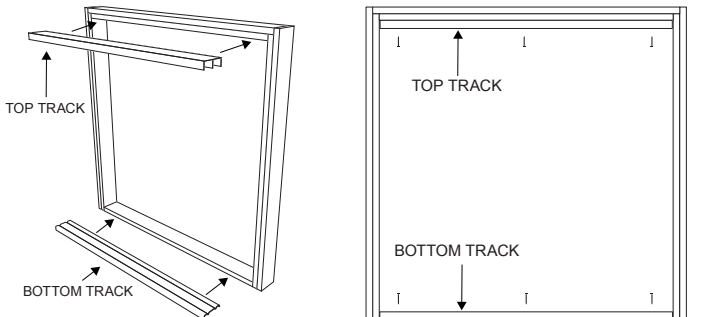

5. Fix Nylon Guides to top of doors 50mm from the edges using screws provided.

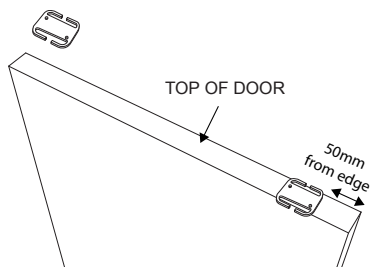

6. Fit door in the opening. Lift door into top track and then lower into bottom track. You may require help to lift the door if it is too heavy. If door does not sit plumb against the jamb adjust the wheel assembly through the hole in side of door using phillips screwdriver.

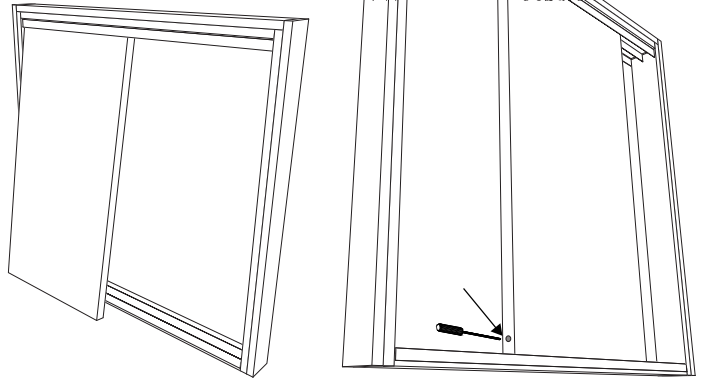

7. To finish off fix Mitred architraves in place (not supplied).

Door size - Unit Height	Width Including 2 Finger Grips per Door		Width No Finger Grips	
	Unit Size	Stud Size	Unit Size	Stud Size
2040 = 2115 / 2340 = 2415				
4 x 870	3670	3675	3460	3465
3 x 870	2770	2775	2610	2615
2 x 870	1870	1875	1760	1765
4 x 820	3470	3475	3260	3265
3 x 820	2620	2625	2460	2465
2 x 820	1770	1775	1660	1665
4 x 770	3270	3275	3060	3065
3 x 770	2470	2475	2310	2315
2 x 770	1670	1675	1560	1565
4 x 720	3070	3075	2860	2865
3 x 720	2320	2325	2160	2165
2 x 720	1570	1575	1460	1465
4 x 620	2670	2675	2460	2465
3 x 620	2020	2025	1860	1865
2 x 620	1370	1375	1260	1265
4 x 520	2270	2275	2060	2065
3 x 520	1720	1725	1560	1565
2 x 520	1170	1175	1060	1065



**HUME  
HOW TO**



Online video instructions are available at:

[www.humedoors.com.au/hume-how-to-install-smartrobe-sliding-doors.php](http://www.humedoors.com.au/hume-how-to-install-smartrobe-sliding-doors.php)

### Components supplied

Smartrobe Doors  
Pre-cut Flat Jamb for track and sill  
Pre-cut Flat Jamb for sides  
Top Track  
Bottom Track

Door Guides  
Door Guide Screws  
Track Screws

Excludes – door furniture

Hume Doors & Timber - [www.humedoors.com.au](http://www.humedoors.com.au)

**Sydney**  
Ph: (02) 9794 1111  
Fax: (02) 9794 1199  
**Brisbane**  
Ph: (07) 3489 6200  
Fax: (07) 3489 6299

**Melbourne**  
Ph: (03) 9799 6888  
Fax: (03) 9799 9688  
**Adelaide**  
Ph: (08) 8280 2000  
Fax: (08) 8280 8099

**Perth**  
Ph: (08) 9470 1800  
Fax: (08) 9472 3802