



HUME DOORS & TIMBER

100% Australian Owned



Pinetrim PLUS

Pre-primed Ready to Finish Timber Door Jamb,
Window Reveal, Skirting & Architrave, & Mouldings

JANUARY
2025

SKIRTING & ARCHITRAVE PRODUCT CATALOGUE



Pinetrim PLUS

Pre-primed Ready to Finish Timber Door Jamb,
Window Reveal, Skirting & Architrave, & Mouldings

Pinetrim Plus provides a durable foundation coat consisting of a primer and undercoat system which is pre-sanded and ready for top coat application.

PINETRIM PLUS PRODUCT INFORMATION, INSTALLATION & USE

■ 3	Product Benefits	■ 3	Environmental Commitment
■ 3	Points to Consider	■ 3	FSC® Certification

PINETRIM PLUS PROFILE DRAWINGS

■ 4	Dressed All Round:	■ 16	18mm Colonial B
■ 4	11mm DAR S4S	■ 17	11mm Australian Colonial
■ 5	18mm DAR S4S	■ 17	18mm NSW Colonial
■ 6	18mm DAR E4E	■ 18	18mm NSW Step
■ 9	30mm DAR E4E	■ 18	11mm Classic
■ 9	42mm DAR S4S	■ 19	18mm NSW Classic
■ 10	Skirting & Architrave:	■ 19	18mm Olympic
■ 10	11mm Bullnose	■ 20	18mm Berkley
■ 10	18mm Bullnose	■ 20	11mm Coolum Cove
■ 11	11mm Single Bevel	■ 21	Small End Section Mouldings:
■ 11	18mm Single Bevel	■ 21	Quad
■ 12	11mm Pencil Round	■ 21	Cladding Products:
■ 12	18mm Pencil Round	■ 21	Lining Board
■ 13	18mm Territory Bevel	■ 22	Window Reveal
■ 13	18mm Splayed	■ 24	Door Jambs:
■ 14	11mm Half Splayed	■ 24	Single Rebated
■ 14	18mm Half Splayed	■ 26	18mm Beveled Loose Stop Jamb Set
■ 14	18mm Melbourne Half Splayed	■ 26	30mm Loose Stop Jamb Set
■ 15	18mm QLD Lambs Tongue		
■ 15	18mm Lambs Tongue		
■ 16	11mm Colonial #1		
■ 16	11mm Colonial #2		

WARRANTY

■ 27	Hume Doors & Timber Warranty
------	------------------------------

BRANCH LOCATIONS

■ 28	Hume Doors National Locations
------	-------------------------------

Pinetrim PLUS

Pre-primed Ready to Finish Timber Door Jamb,
Window Reveal, Skirting & Architrave, & Mouldings

Pinetrim Plus is manufactured from plantation grown FSC and PEFC certified Radiata pine. Product benefits are:

- **Maximum Stability:** Pinetrim Plus is produced from a defect free, finger jointed Radiata product.
- **Defect Free:** The priming and sanding process has been developed to provide an imperfection-free finish.
- **Superior Paint Finish:** The three-coat priming system used in the manufacture of Pinetrim Plus has been developed over 10 years and proven to be hard wearing whilst giving a superior base for a second-to-none final paint finish.

Points to Consider:



How To Specify

Pinetrim Plus suits all applications and requirements within the residential and commercial markets. The following must be considered before use of the product:

- Site-specific conditions, moisture, fixing point;
- Durability requirements of all fastenings;
- Regional or local building codes for treatment requirements;
- Anything else relevant to the project.



Installation & Fixing

- Ensure all cutting tools and saw blades are sharp and in good order for best performance. A finishing blade with a thin kerf or high tooth count is recommended when using power saws.
- Prepare boards by lightly sanding and priming all cut ends with premium acrylic primer undercoat.
- 11mm thick Pinetrim Plus mouldings should be fastened with a 38mm finishing brad.
- 18mm thick Pinetrim Plus mouldings should be fastened with a 50mm finishing brad.
- 30mm thick Pinetrim Plus mouldings should be fastened with a 63mm finishing brad.
- It is important not to over-fix Pinetrim Plus. We do not recommend nailing within 20mm of the profile end, as splitting may occur.
- When joining the profile, mitre cuts should be used and the joint must be glued using either a PVA or PU adhesive.
- Pinetrim Plus can also be fixed using a contact and wall adhesive in accordance with the manufacturer's instructions.



Painting

Prior to painting fill all nail holes from the fixing process with a quality acrylic or wood filler. Once cured, sand excess filler with a 180 grit sandpaper.

- Ensure mouldings are free of dust and dirt prior to painting.
- Apply two coats of either acrylic, enamel or latex paint, sanding between coats to achieve the ultimate finish.
- For best results, we recommend Pinetrim Plus is painted within one month of installation.



Hume Safety

- Ventilated working areas.
- PPE (Personal Protective Equipment).
- Correct tools for the job.

Environmental Commitment:

Hume Doors & Timber is committed to operating its entire business in an environmentally sustainable manner at all times including but not limited to:

- Hume solar power scheme – Reducing our carbon footprint.
- Reusing and recycling by-products, packaging and waste material.
- Reducing the levels of consumables used.
- Capturing, storing and using rainwater for our water needs.
- Maximise transport needs, thus reducing our energy requirements.

FSC Certification:

- Hume Doors & Timber is also a certified member of the Forest Stewardship Council (SGS HK – CoC-010386, SGS HK – CoC- 330930, SA – CoC- 003052).

Dressed All Round | 11mm DAR S4S

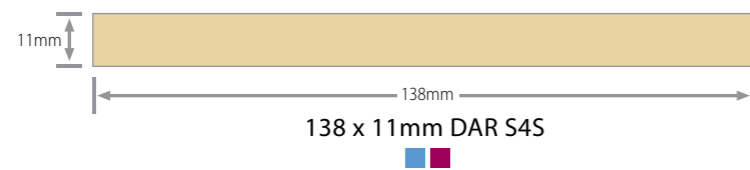
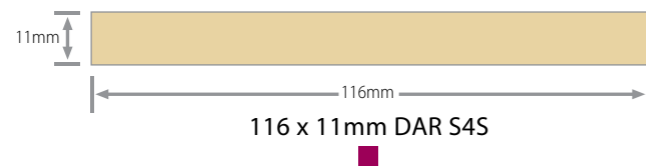
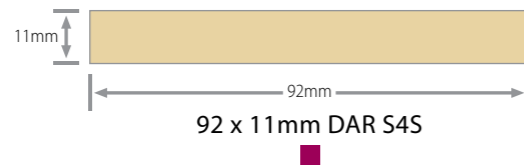
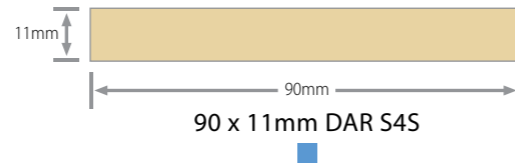
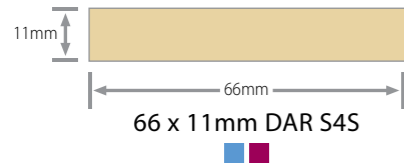
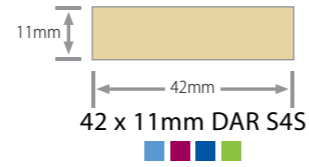
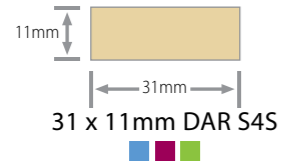

Dressed All Round | 18mm DAR S4S

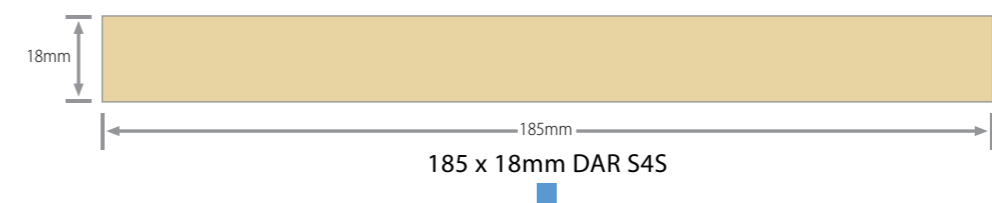
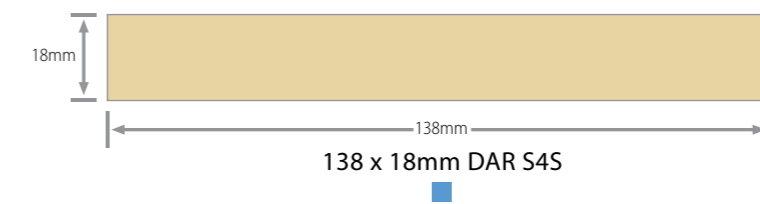
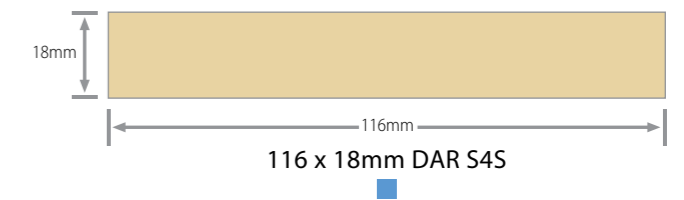
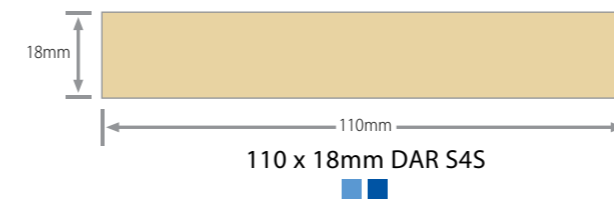
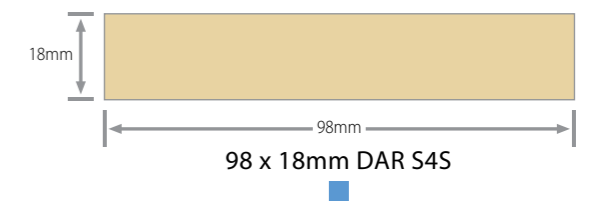
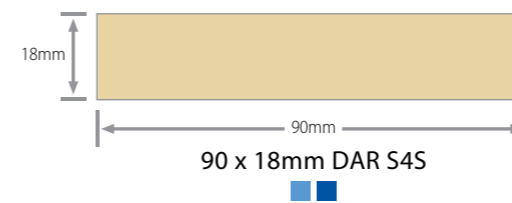
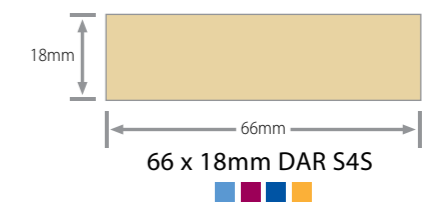
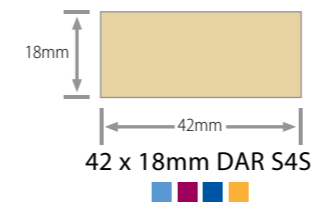
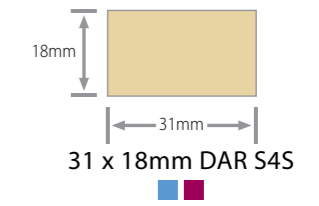
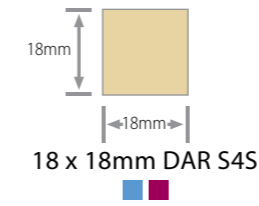

Dressed All Round | 18mm DAR E4E

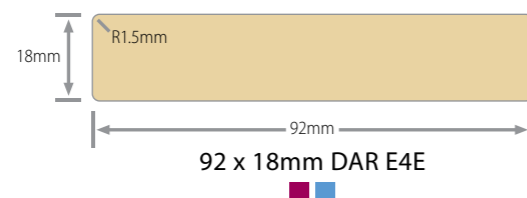
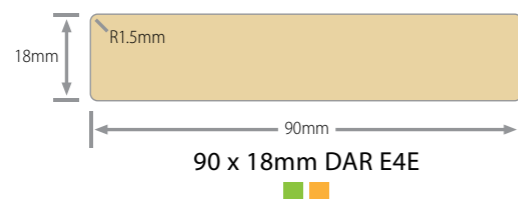
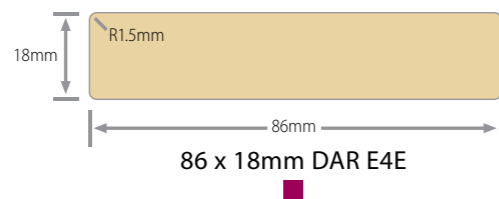
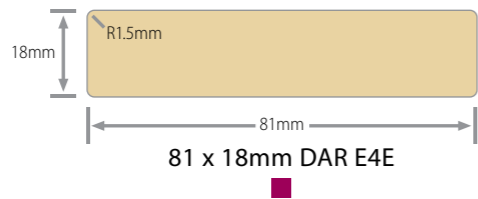
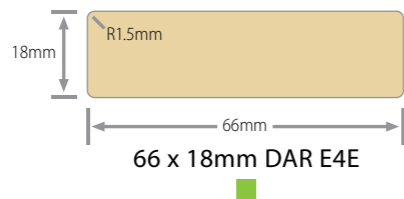
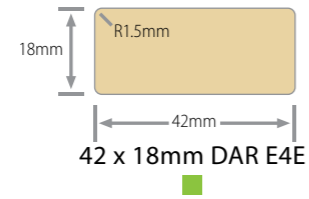

Dressed All Round | 18mm DAR E4E (continued)

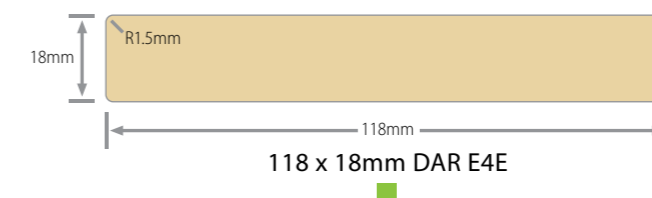
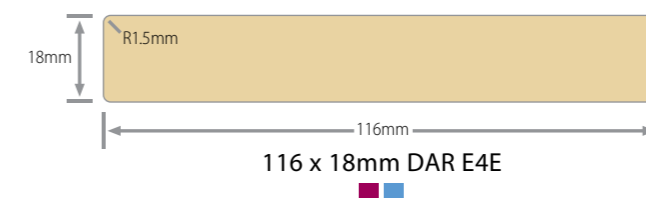
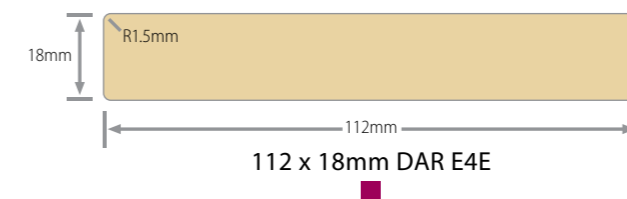
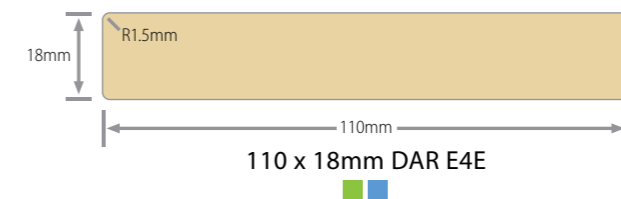
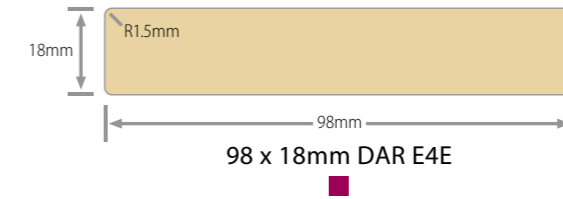

Dressed All Round | 18mm DAR E4E (continued)

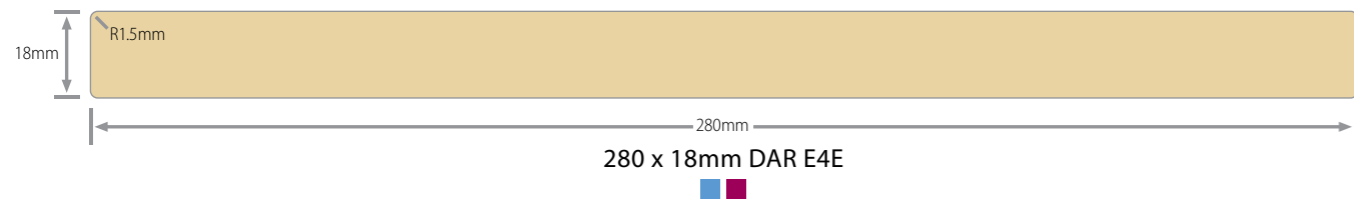
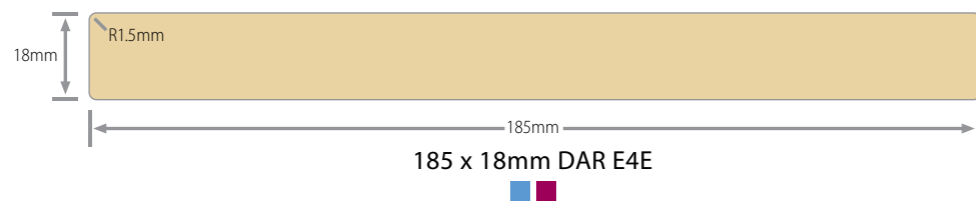
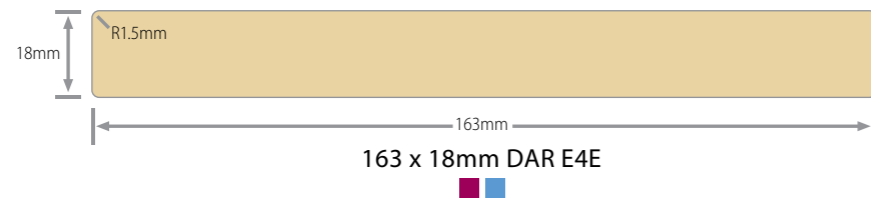
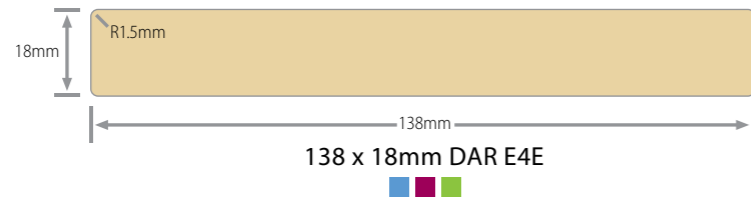
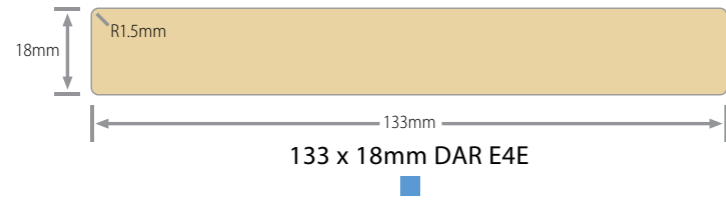

Dressed All Round | 30mm DAR E4E

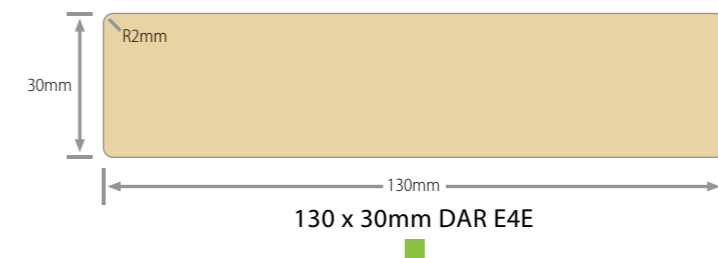
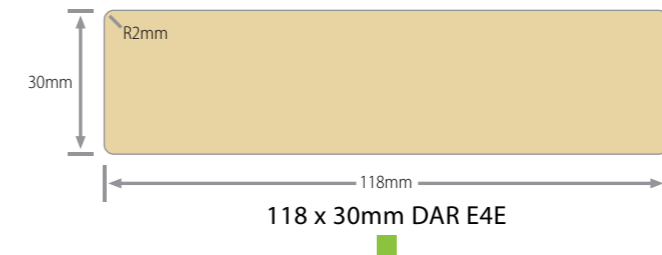
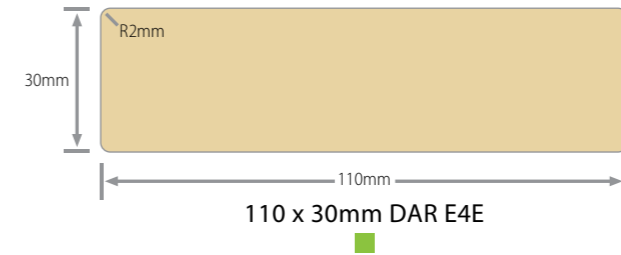

Dressed All Round | 42mm DAR S4S

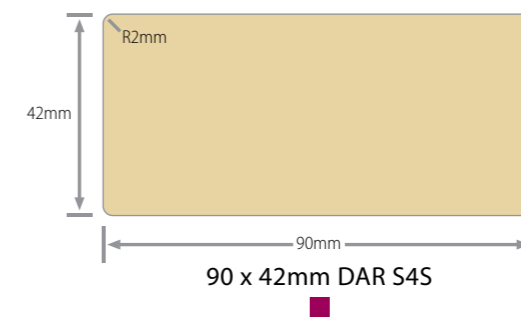

11mm Bullnose

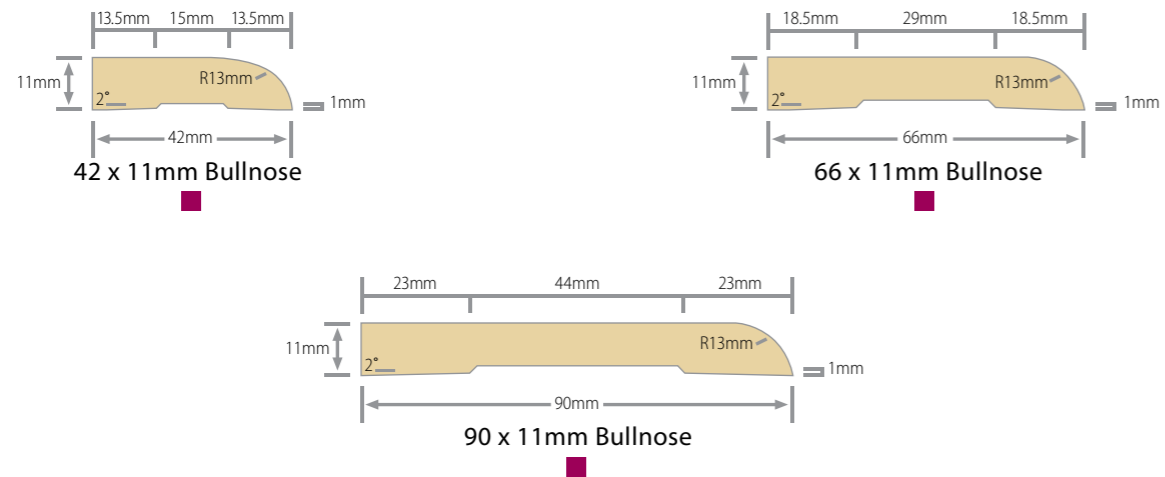

11mm Single Bevel

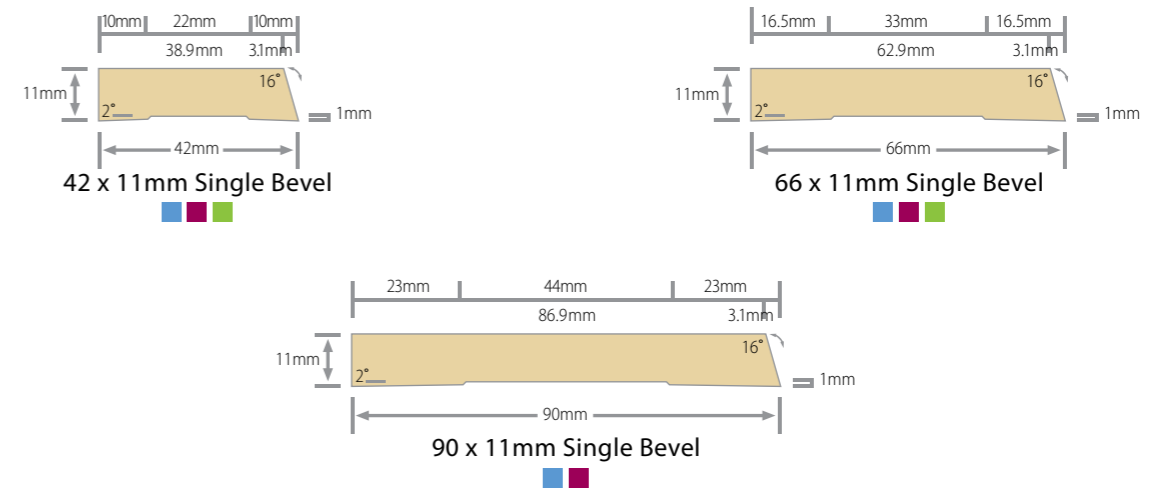

18mm Bullnose

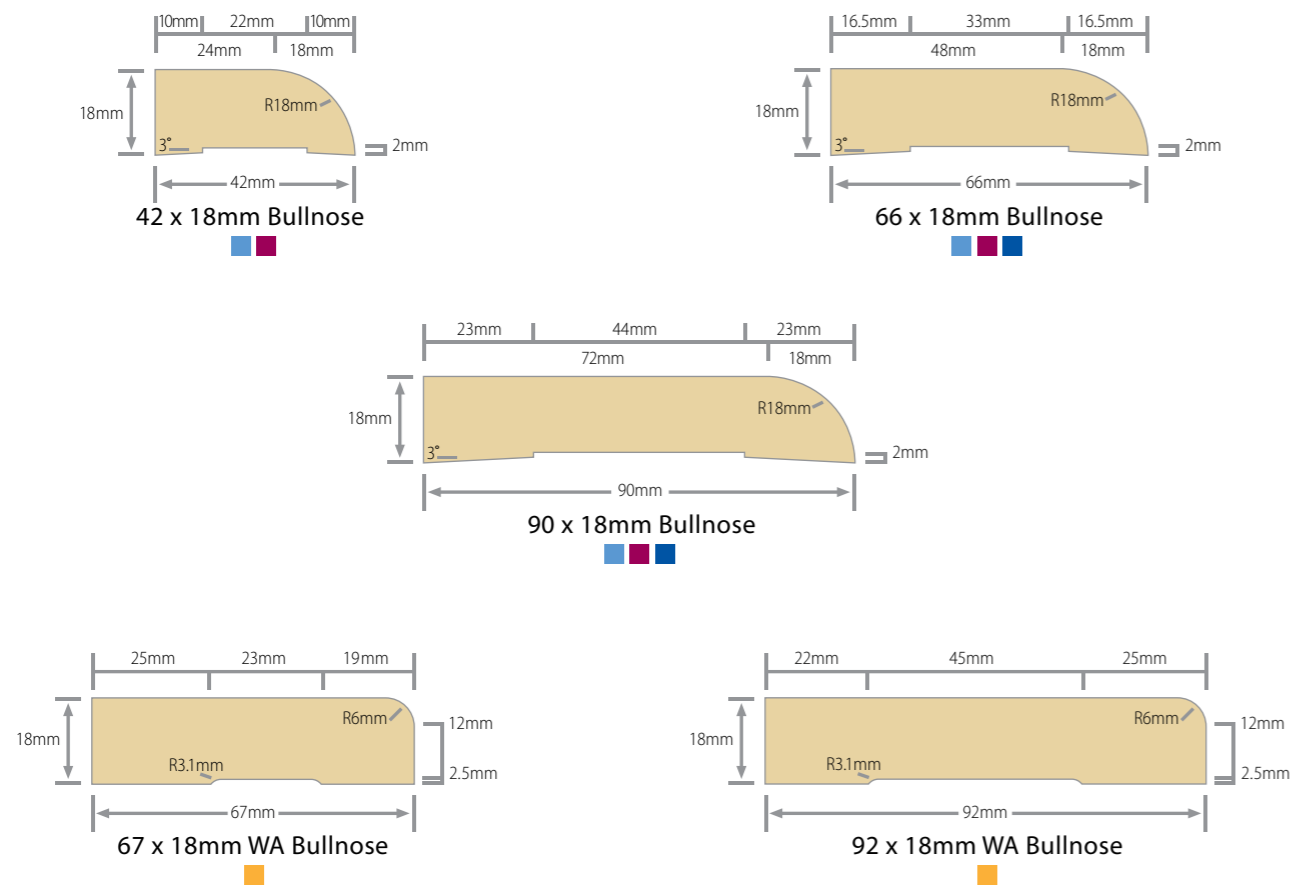

18mm Single Bevel

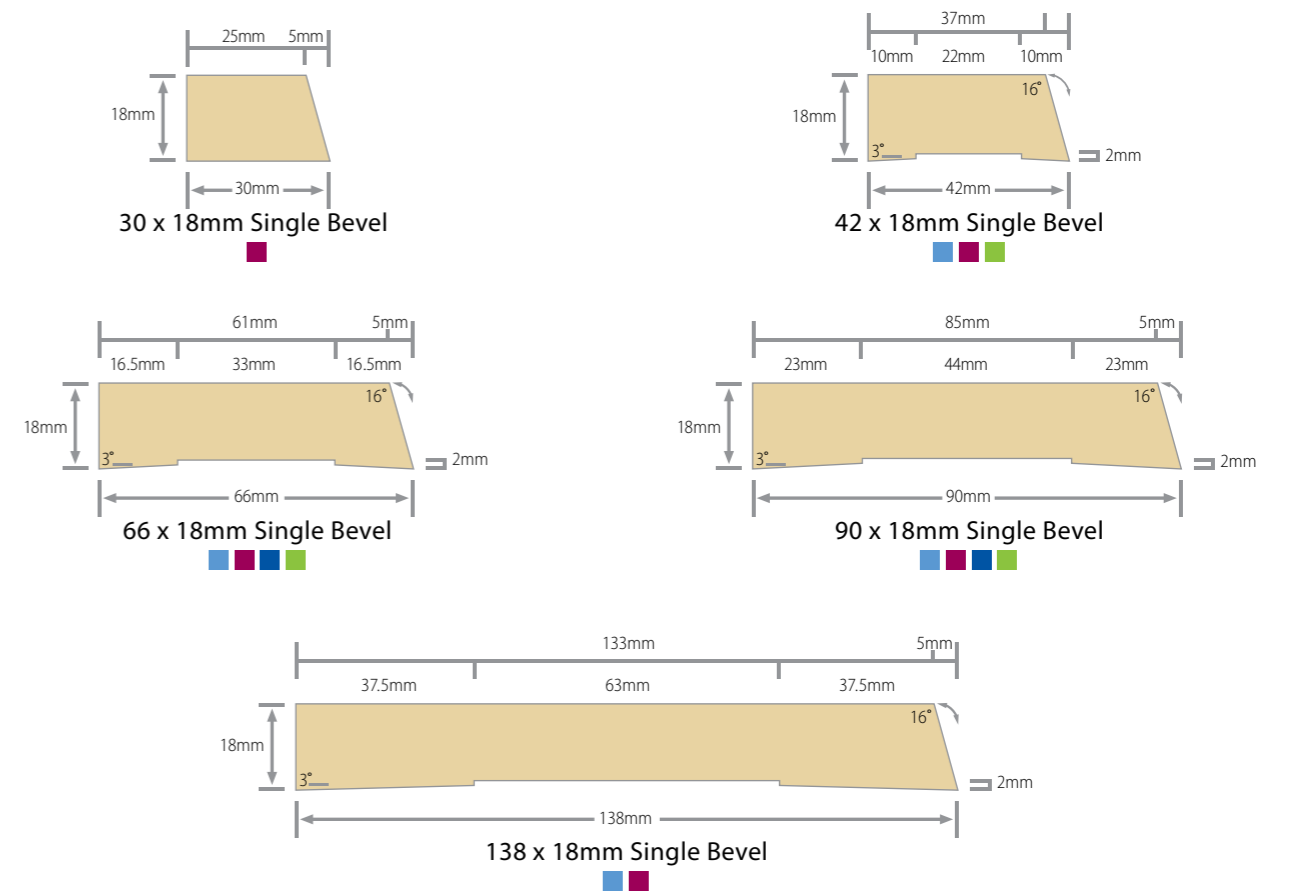

11mm Pencil Round

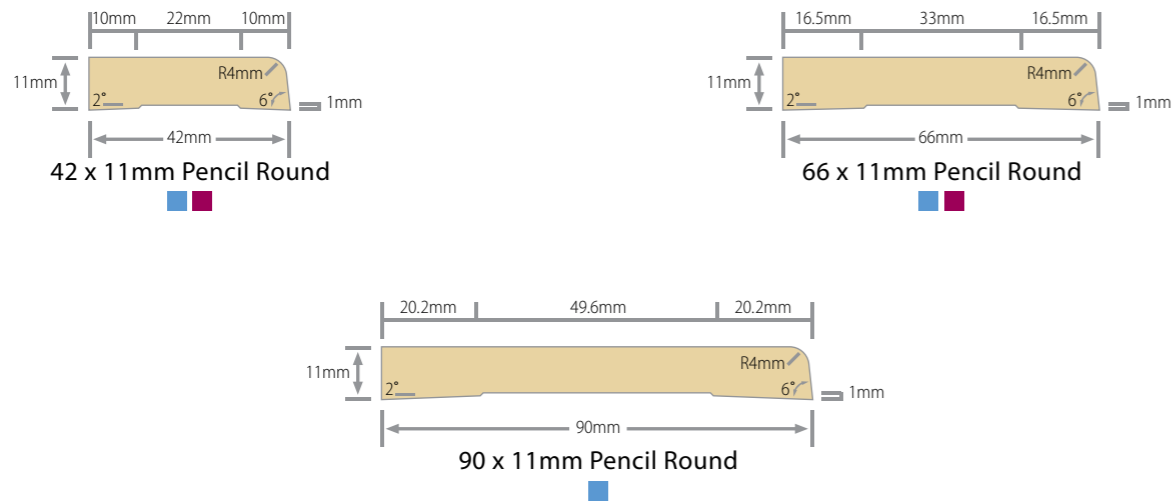

18mm Pencil Round

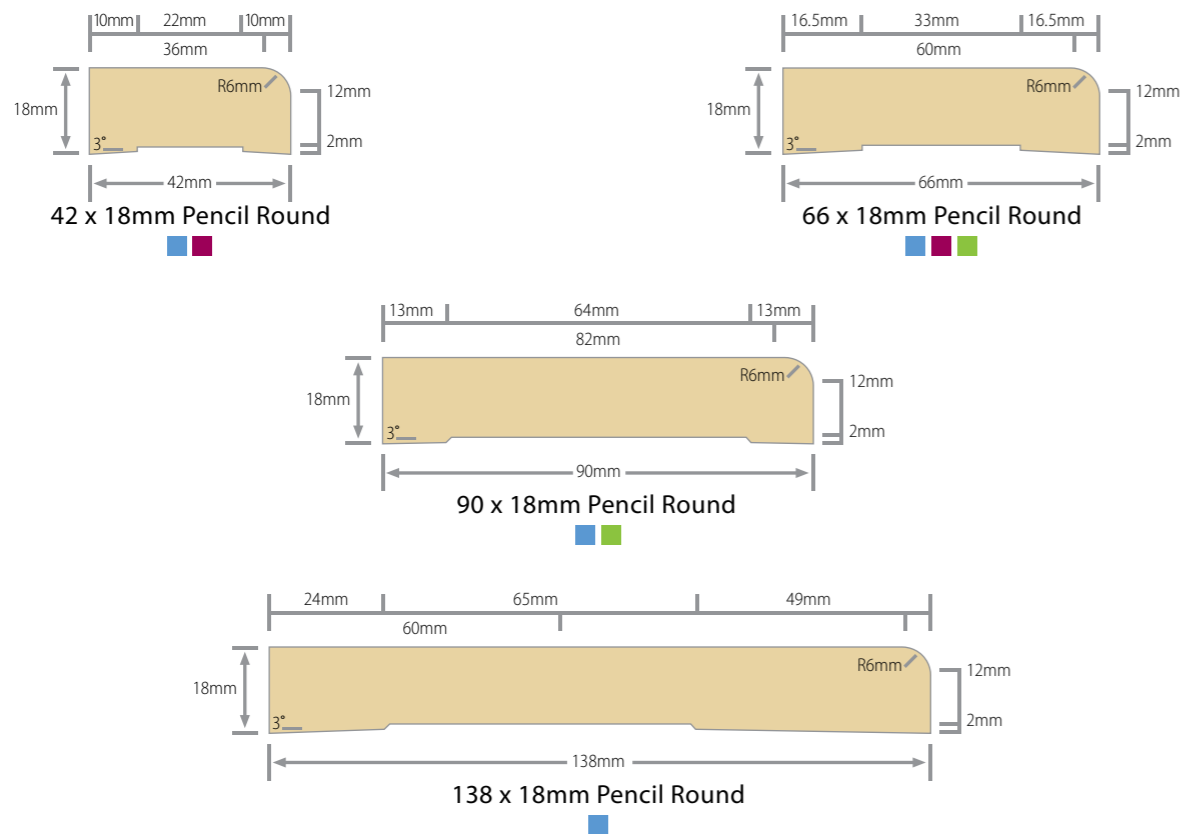

18mm Territory Bevel

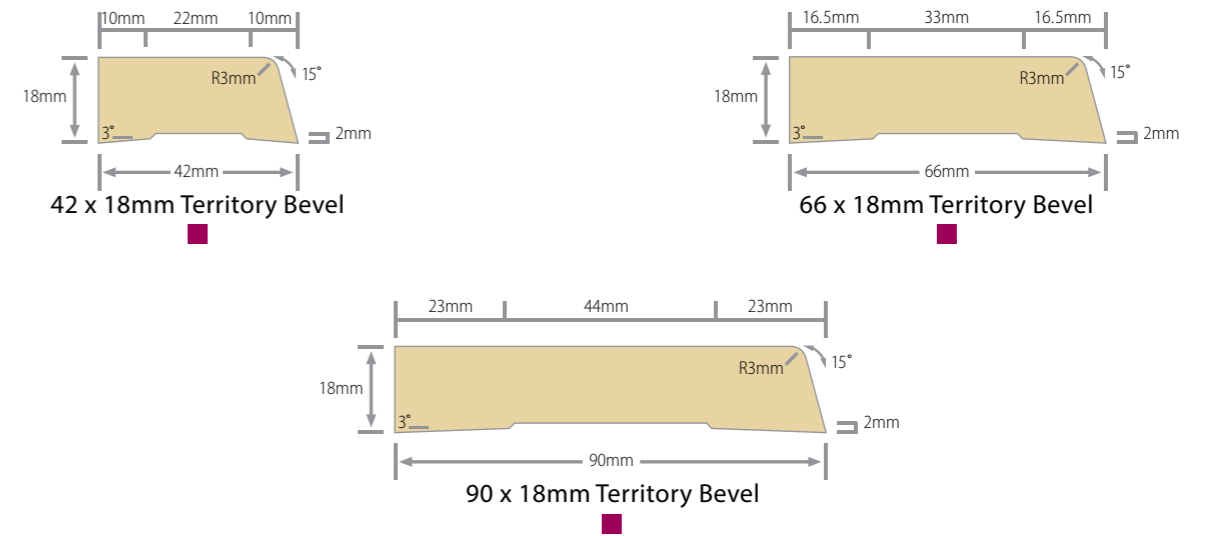

18mm Splayed

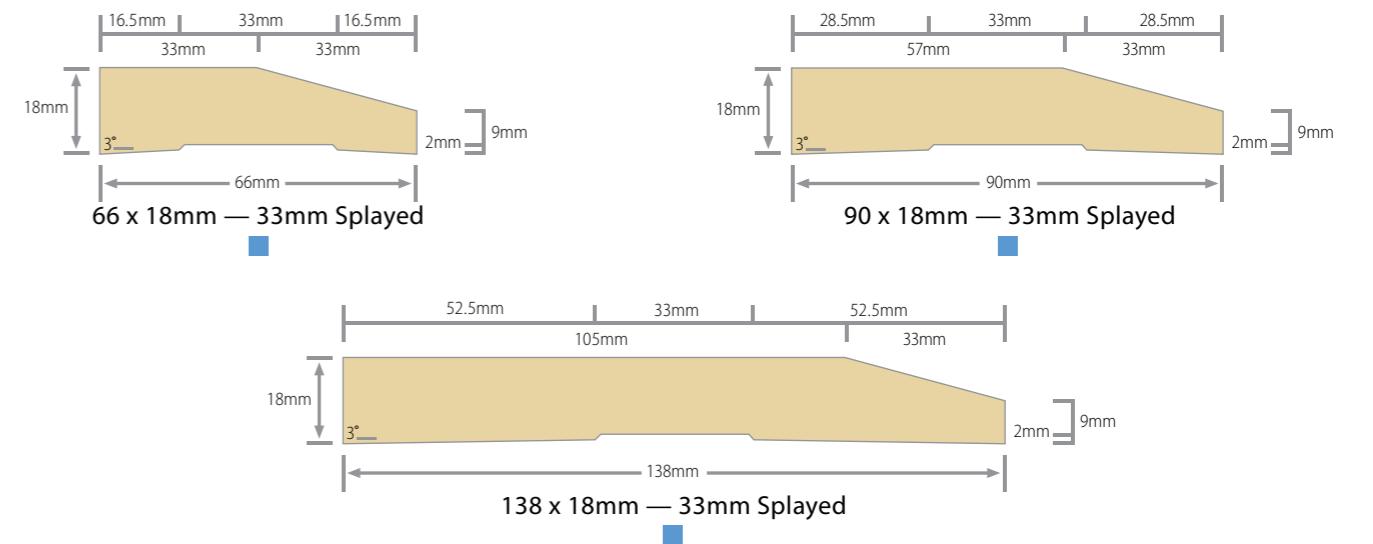

11mm Half Splayed

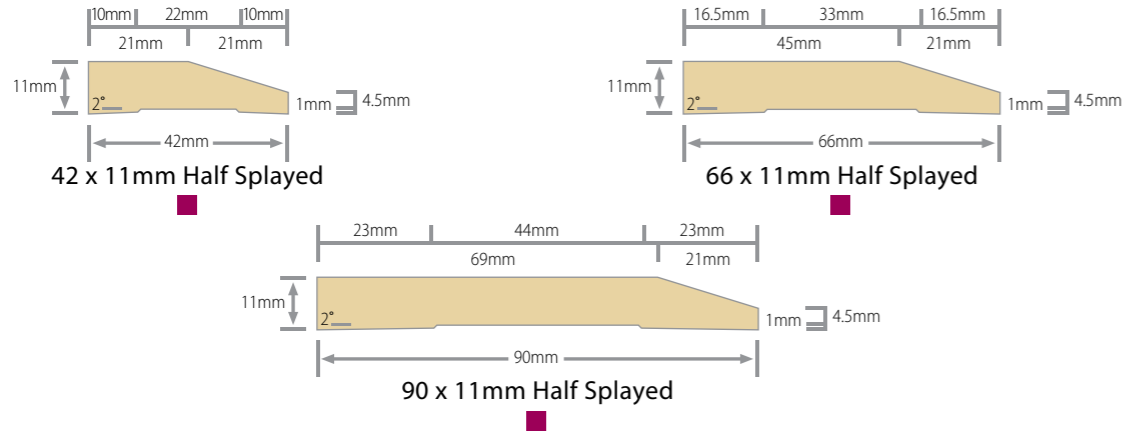

18mm Half Splayed

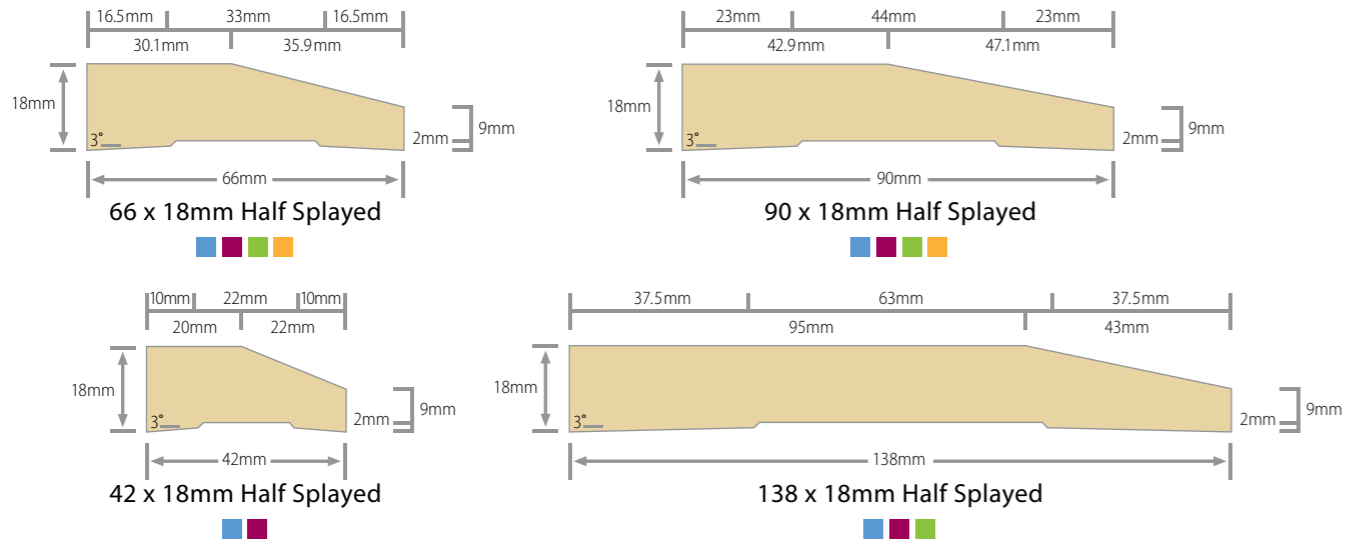

18mm Melbourne Half Splayed

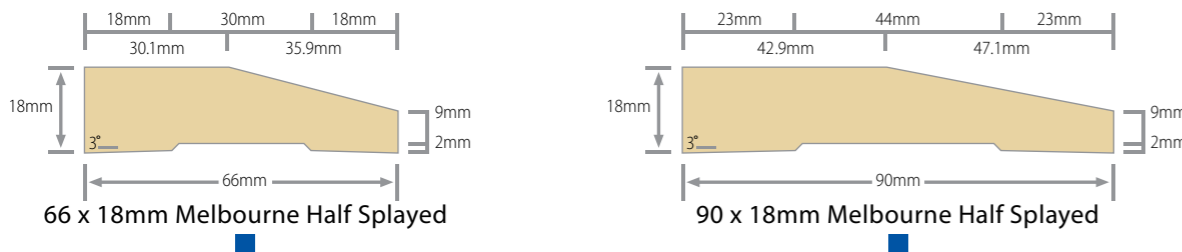

18mm QLD Lambs Tongue

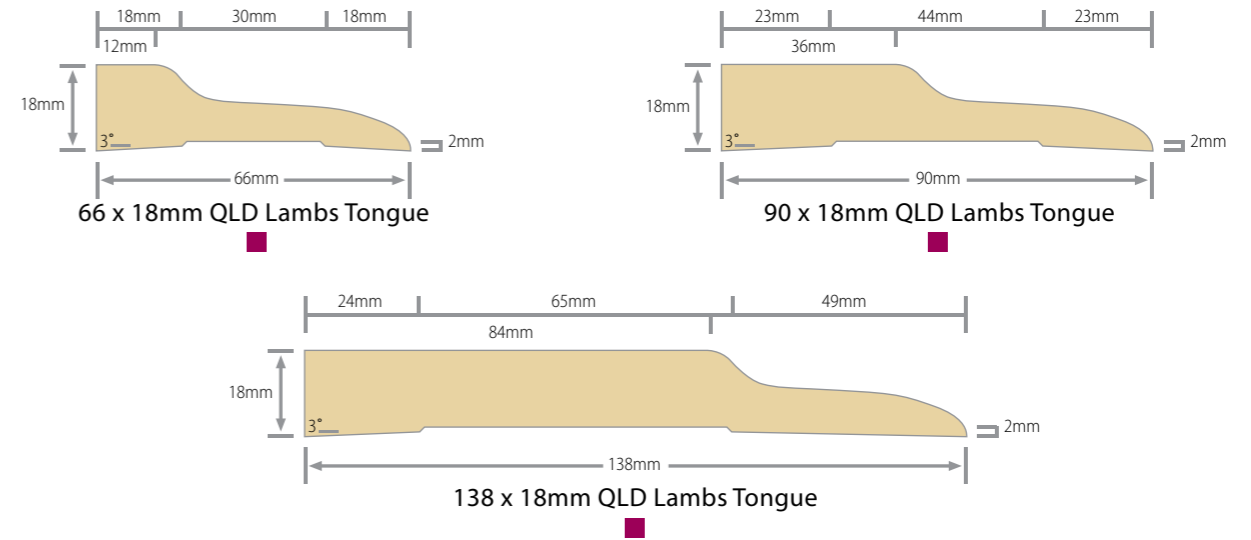

18mm Lambs Tongue

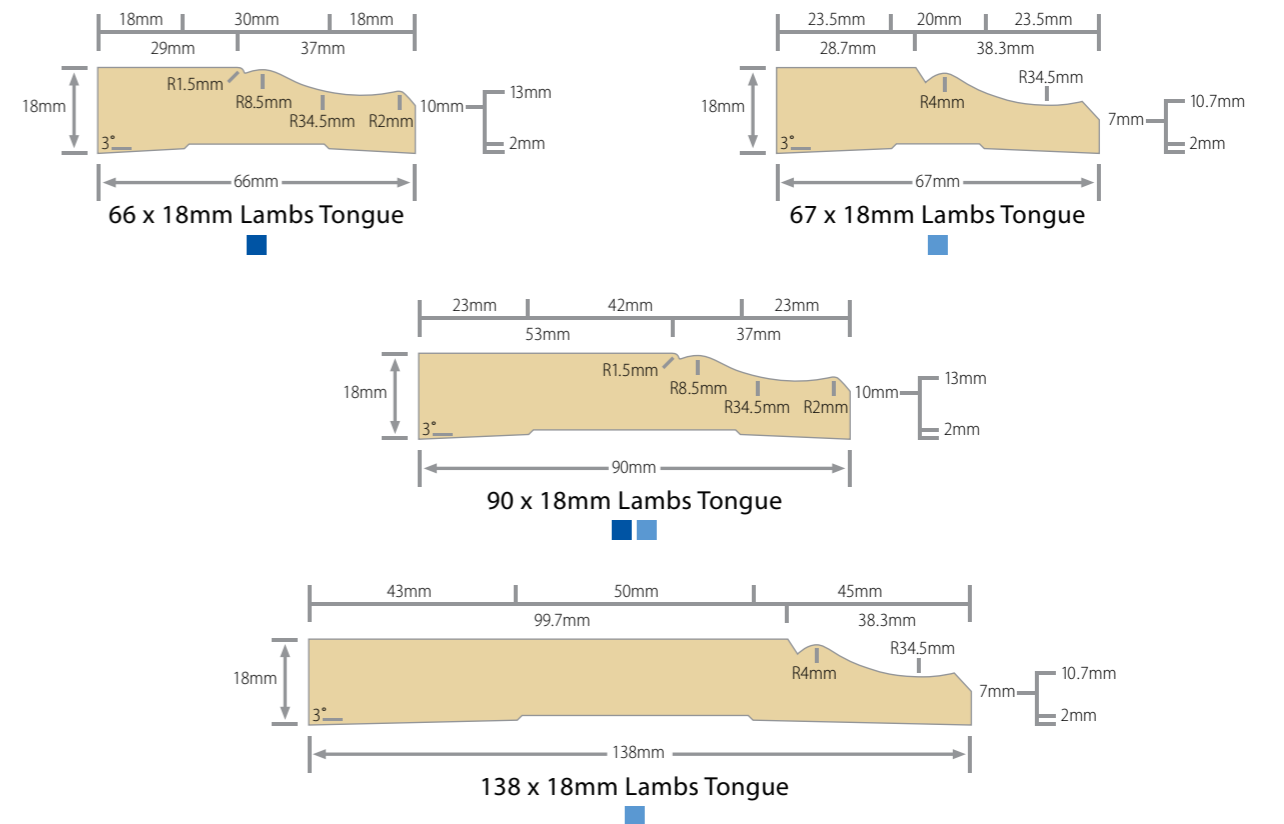

11mm Colonial #1

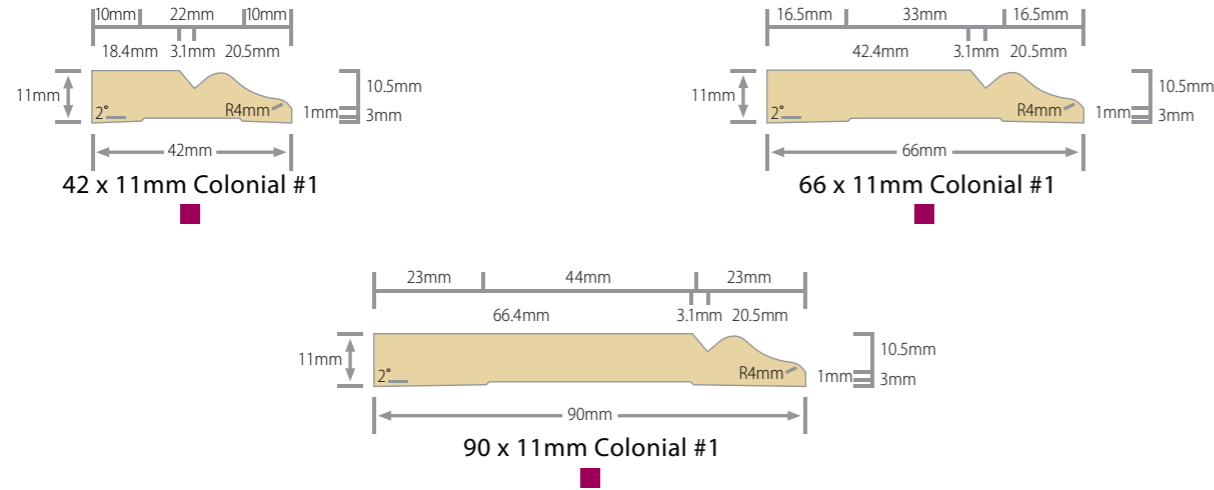

11mm Colonial #2



18mm Colonial B

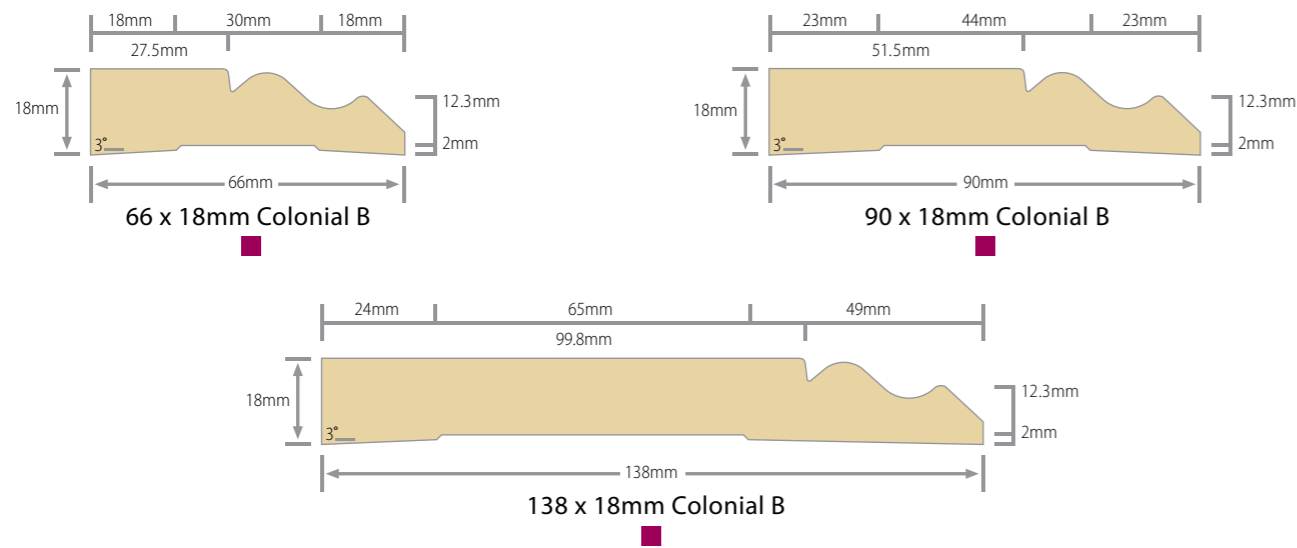

11mm Australian Colonial

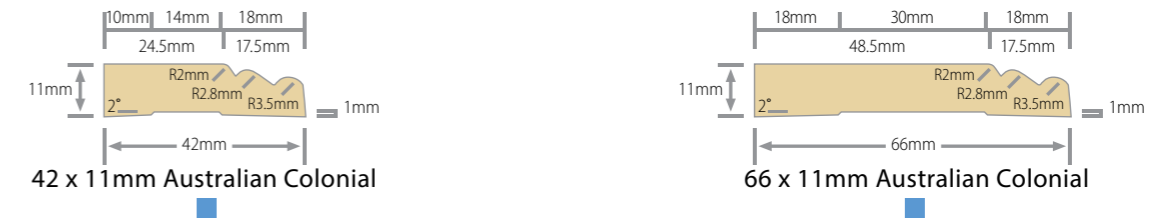

18mm NSW Colonial

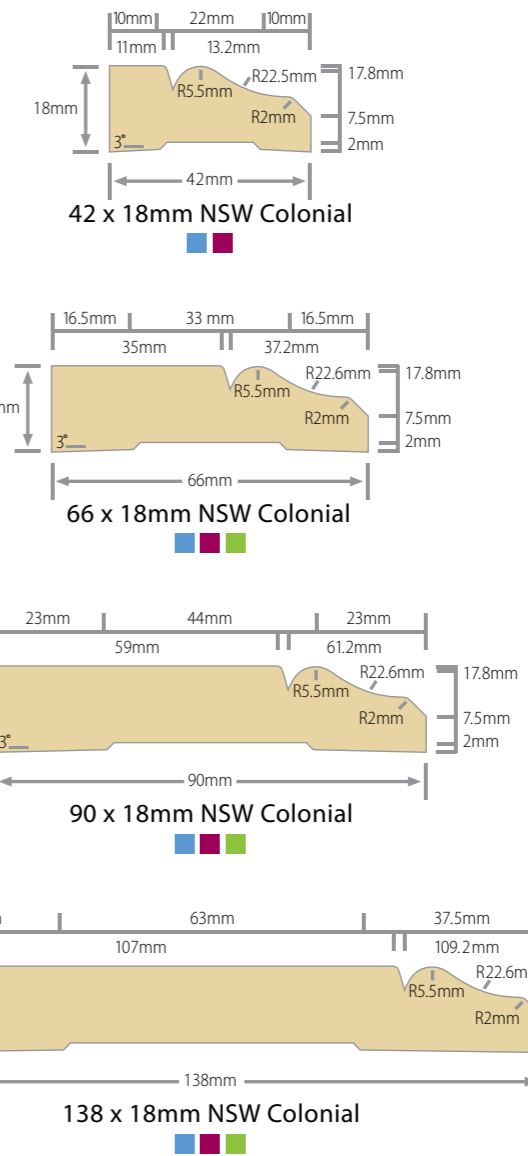

18mm NSW Step

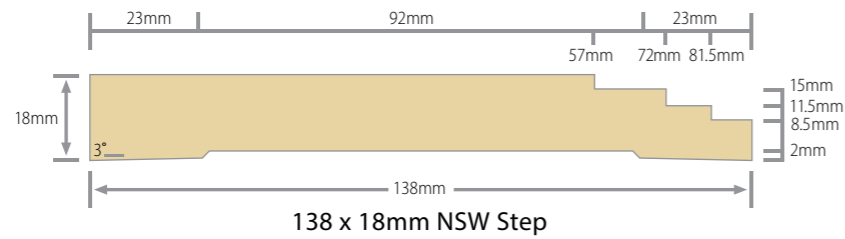
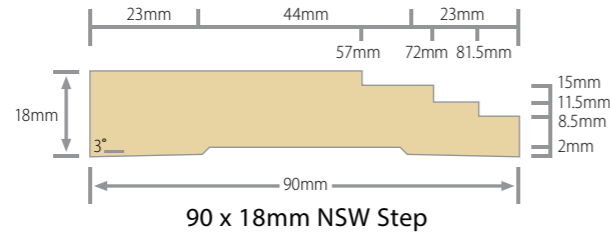
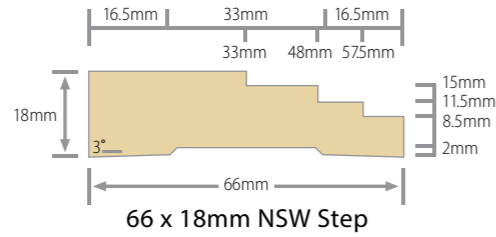

11mm Classic

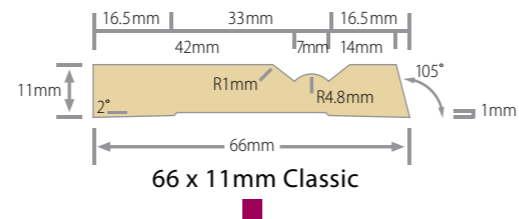
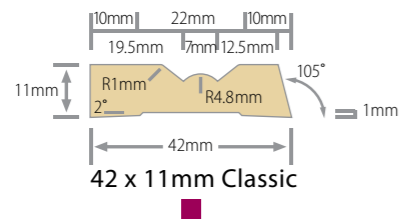

18mm NSW Classic

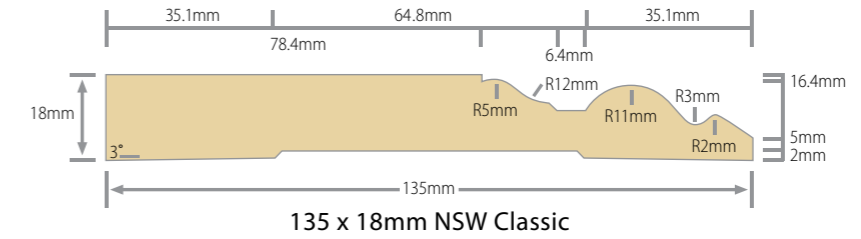
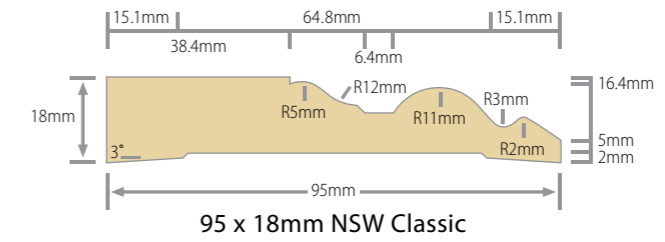
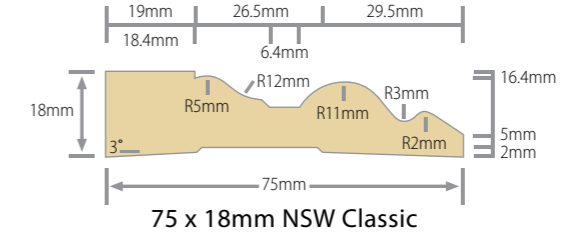

18mm Olympic

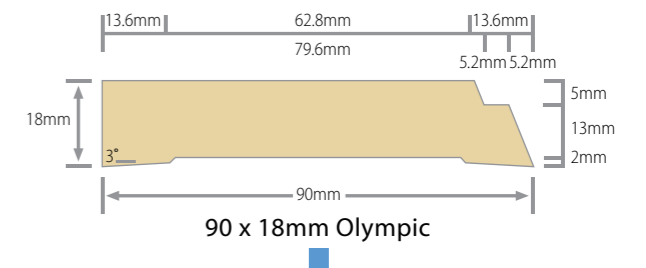
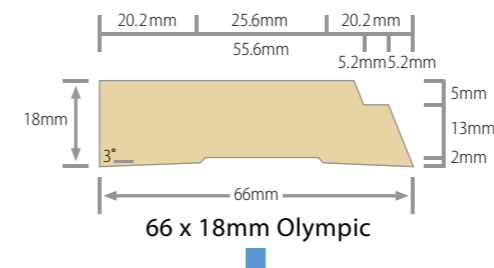

18mm Berkley

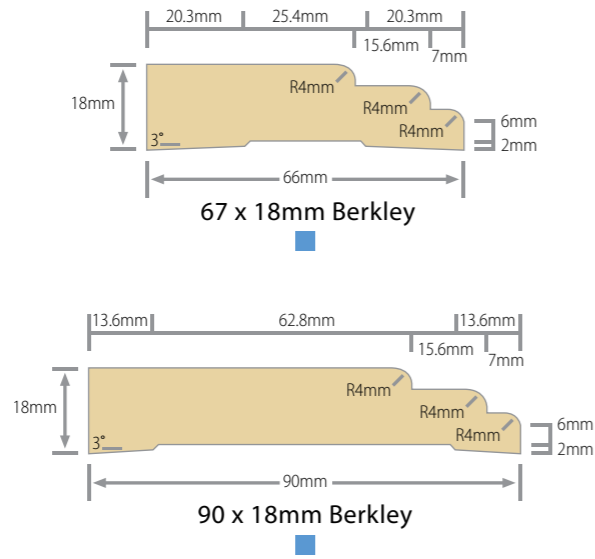

11mm Coolum Cove

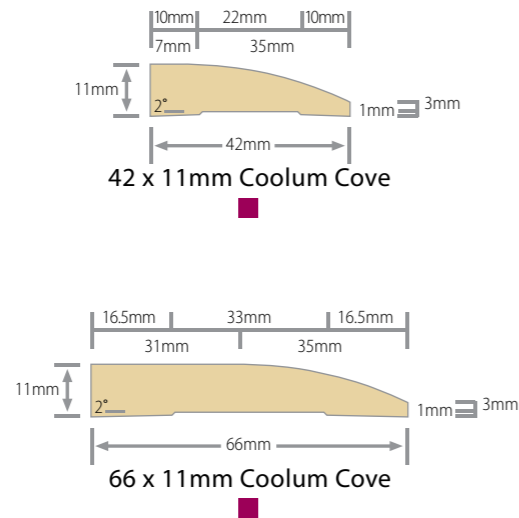

Small End Section Mouldings

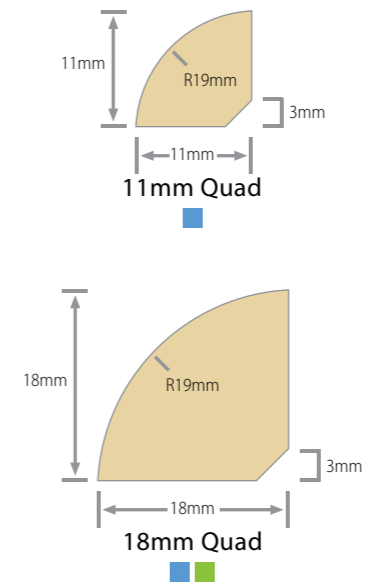

Lining Board

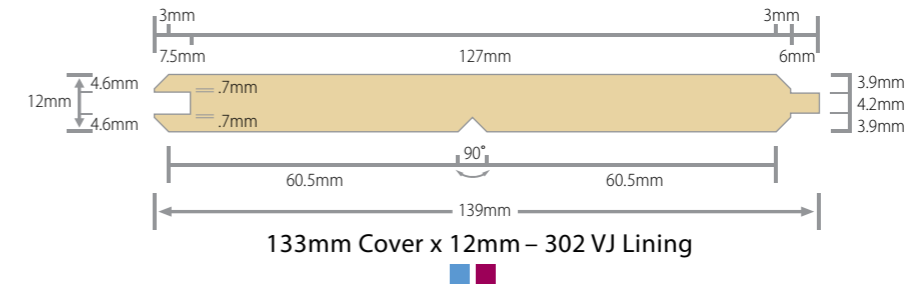

Window Reveal

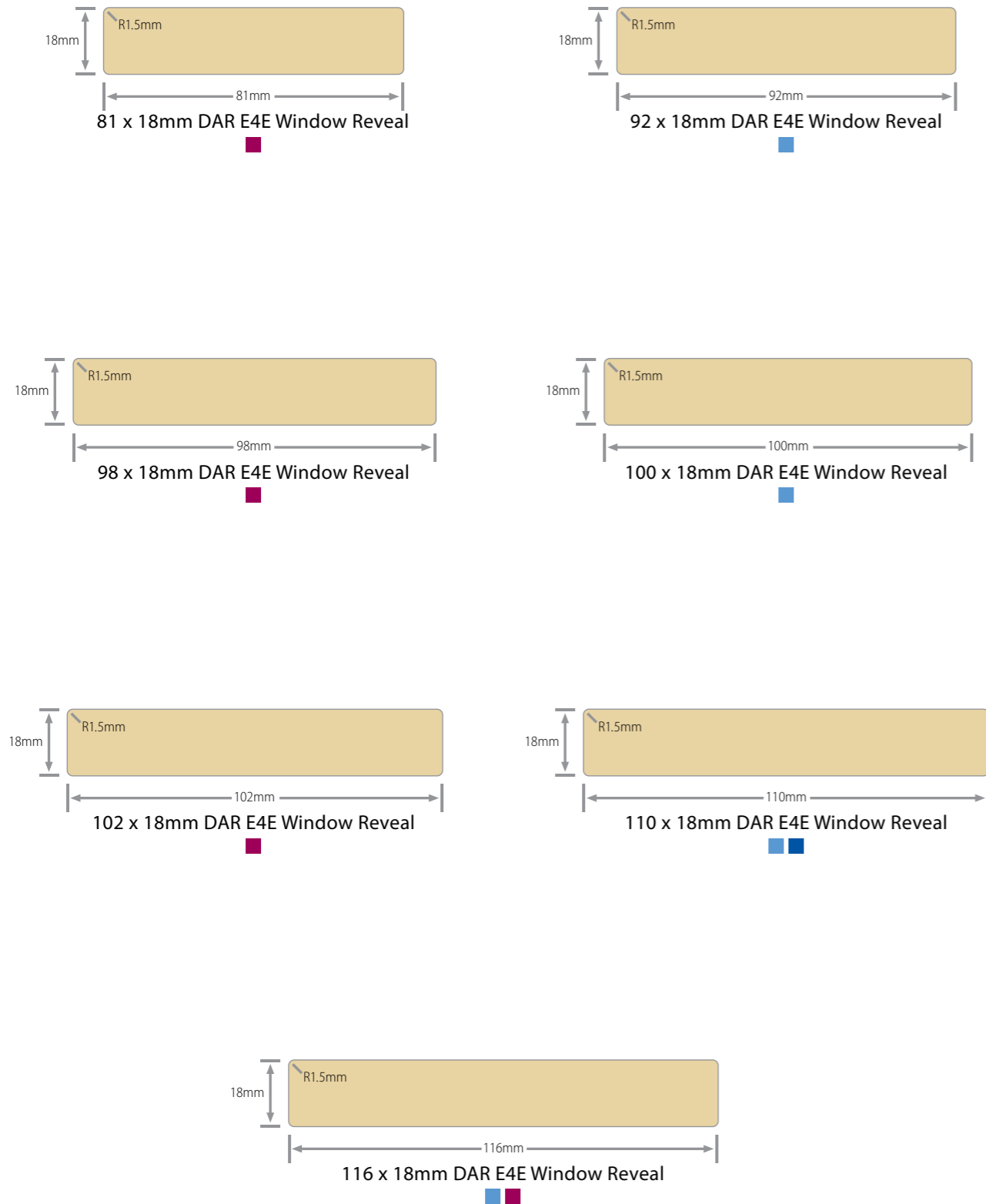

Window Reveal (continued)

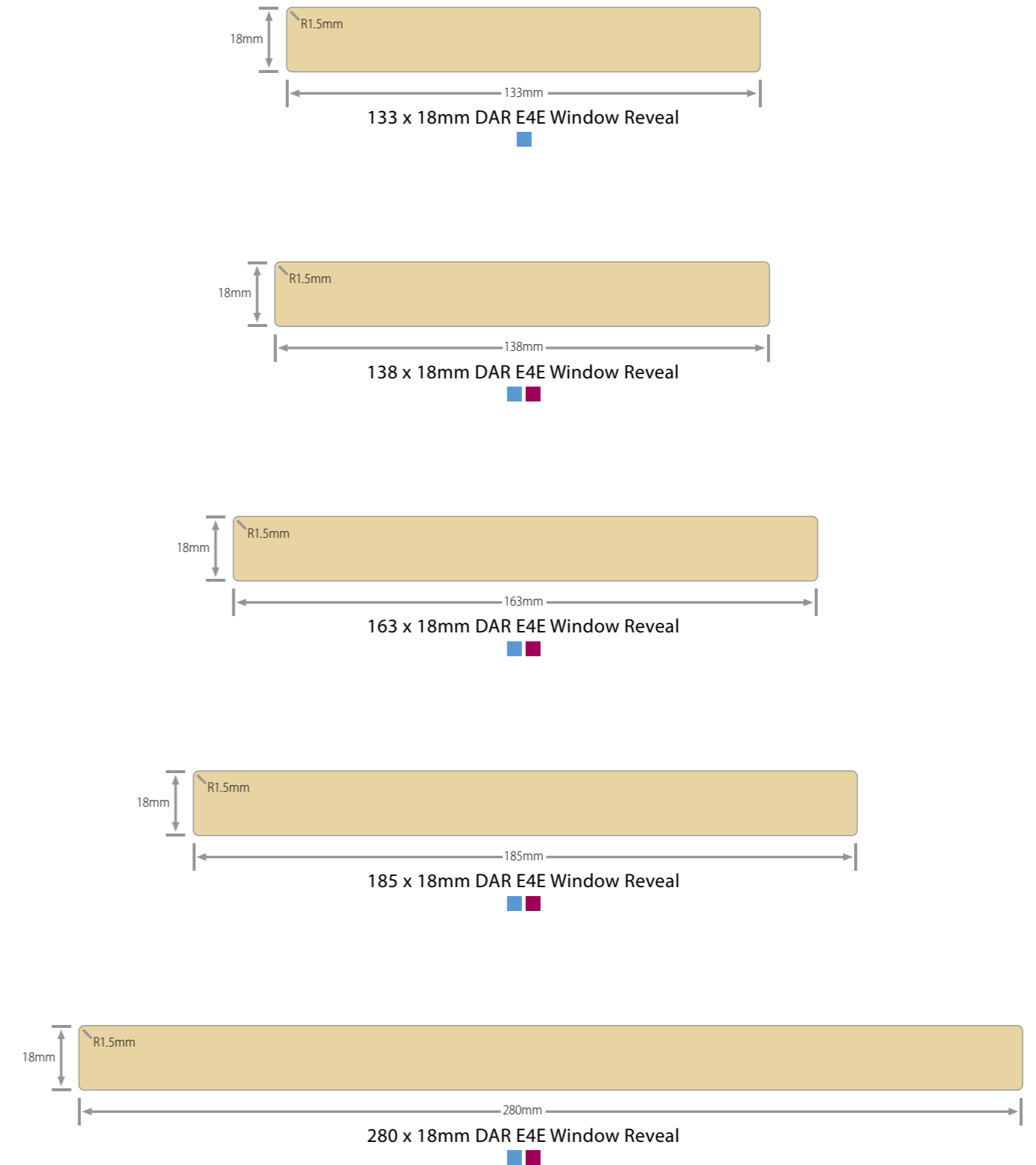

Single Rebated Door Jamb

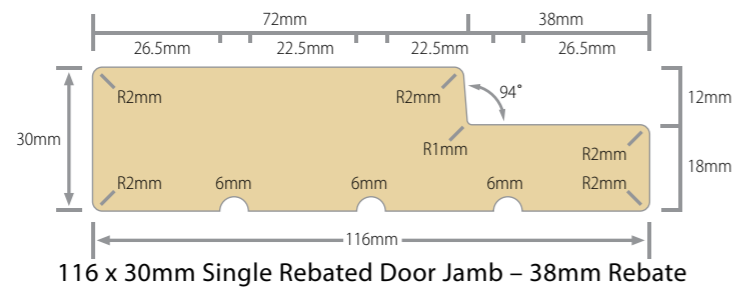
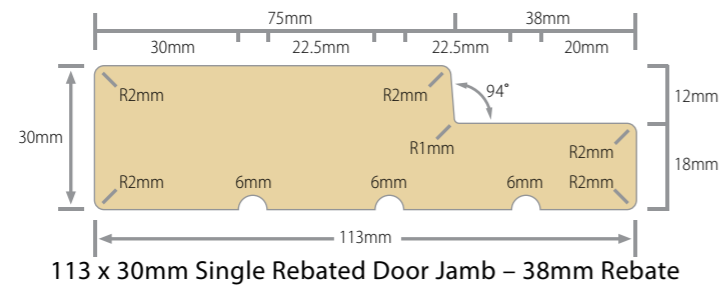
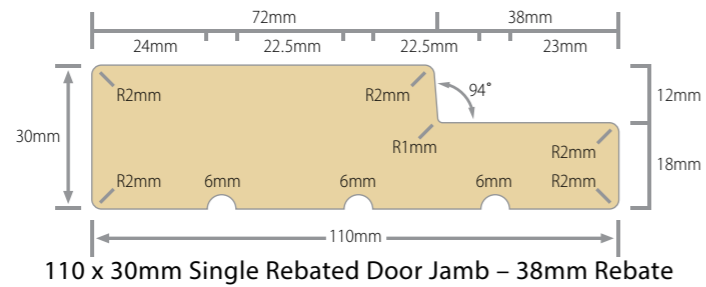
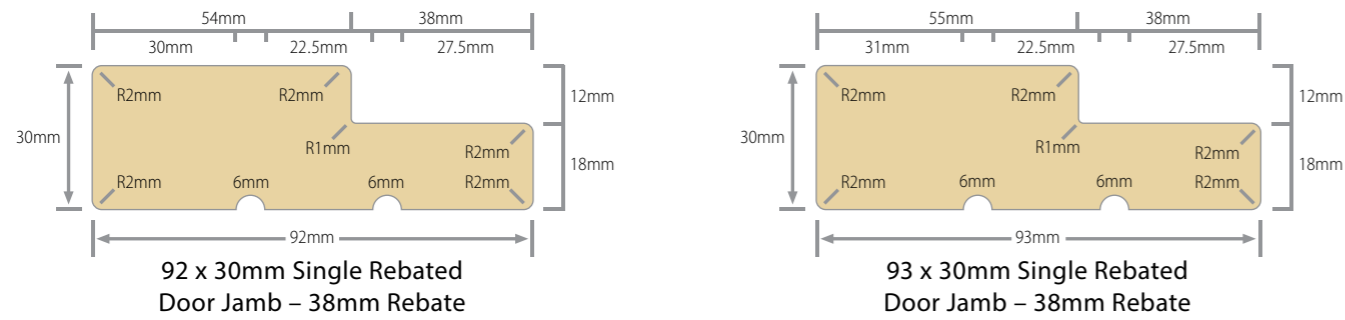

Single Rebated Door Jamb (continued)

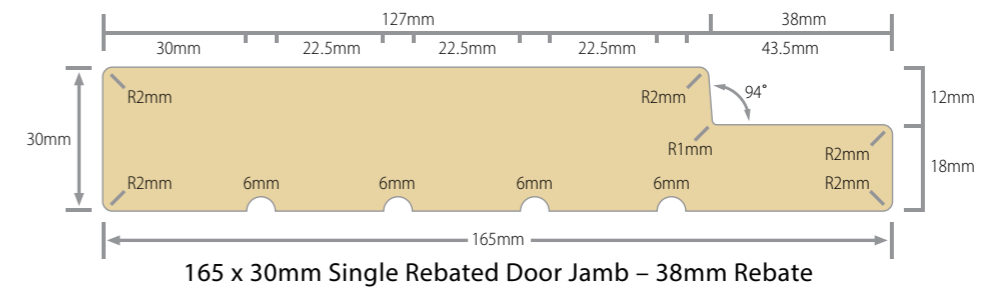
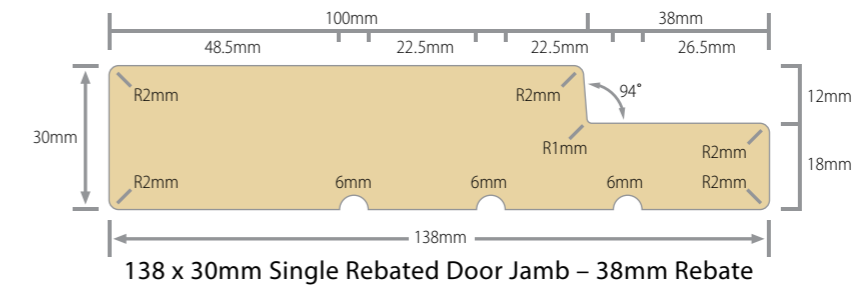
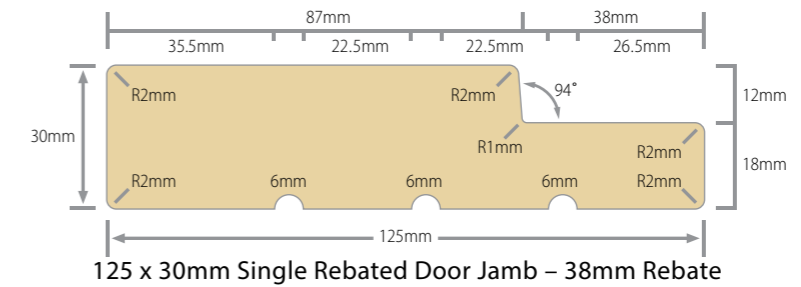
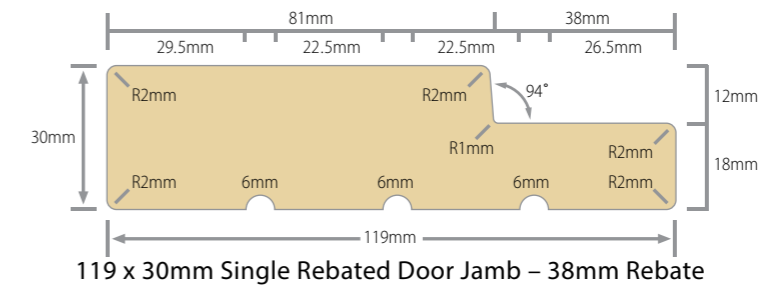

18mm Beveled Loose Stop Jamb Set

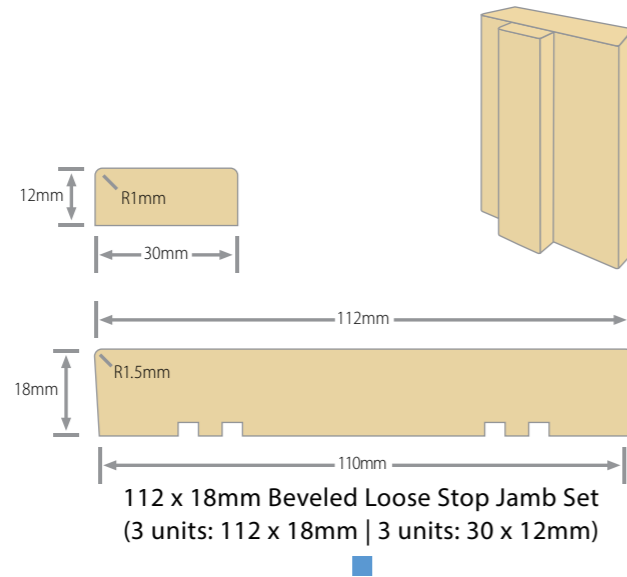

30mm Loose Stop Jamb Set

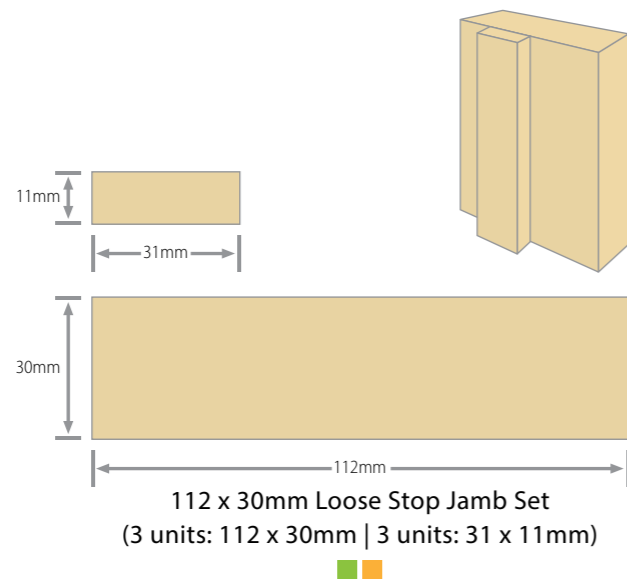

This Warranty applies to Hume Doors & Timber Pinetrim Plus products supplied for use as an internal finishing timbers / moulding product.

Warranty Period:

- 5 years from proven date of purchase.
- All inquiries relating to this Warranty must be directed to the supplier or installer in the first instance.

Hume Doors & Timber Warrants That:

At the time of delivery to the merchant or site (where applicable), Pinetrim Plus will be free from factory defects and conforms to the current Hume Doors & Timber warranted condition.

In The Event of Proven Product Failure of Pinetrim Plus Products to Meet the Warranted Condition, Subject to the Terms of This Warranty, the Following Applies:

- Hume Doors & Timber will at its discretion, supply replacement Pinetrim Plus product without charge, or refund the value of the product. The installer will be responsible for the cost of removing and installing any replacement materials.
- Other losses or damage caused by product failure are not covered.
- Hume Doors & Timber's obligations under this Warranty are limited to the replacement of defective Pinetrim Plus product or the value of the Pinetrim Plus Product. The value of the materials will be reduced pro-rata based on the remaining life of the product.
- Hume Doors & Timber reserves the right to supply other compatible materials for repair should the warranted materials no longer be supplied by Hume Doors & Timber.

This Warranty is Subject To:

- Proof of date of purchase of the product.
- Evidence of failure.
- Receipt of a written claim from the claimant either within 30 days of when the defect would have become reasonably apparent, or, if the defect was reasonably apparent prior to installation, then the claim must be made prior to installation. The claim must include full details of the alleged defect, including a copy of the proof of purchase. Any claim is subject to inspection by Hume Doors & Timber before any remedial action is undertaken.
- Evidence satisfactory to Hume Doors & Timber that all storage, handling and maintenance requirements (as advised by Hume Doors & Timber) has been carried out.
- The Warranty does not cover failure or problems caused by defective use, failure relating to improper design of the project structure, structural failure, settlement, movement of materials to which the product is attached or dependent on, acts of God including but not limited to earthquakes, cyclones, floods or other severe weather conditions, inadequate maintenance, growth of mould, mildew, fungi, bacteria or any organism on any product, or has acts or omissions of a third party over whom Hume Doors & Timber has no control.
- The Warranty does not cover product failure arising from the failure to follow Hume Doors & Timber design, installation, storage, handling or maintenance advice.
- Normal wear and tear is excluded from this Warranty.

CONTACT DETAILS



HUME DOORS
& TIMBER

QUEENSLAND



HUME DOORS & TIMBER (QLD) PTY LTD

ABN 25 009 994 996

86-92 Mudgee Street, Kingston QLD 4114
PO Box 2243, Logan City D.C. Qld 4114
P | 07 3489 6200
E | sales@humedoorsqld.com.au

Cairns Branch

4-6 Ponzo Street, Woree, QLD 4868
P | 07 4041 2099
E | hdtcairns@humedoorsqld.com.au

Sunshine Coast Branch

14 Junction Drive, Coolum Beach Qld 4573
P | 07 5446 2640
E | ncsales@humedoorsqld.com.au

Northern Territory Branch

3 Adams Road (Cnr Beresford),
Yarrawonga NT 0830
P | 08 8932 3733
E | hdtnt@humedoorsqld.com.au

NEW SOUTH WALES



HUME DOORS & TIMBER – (AUST) PTY LTD

ABN 39 001 472 493

Sydney Office & Showroom

120 Hume Highway, Lansvale NSW 2166
PO Box 333, Cabramatta NSW 2166
P | 02 9794 1111
E | info@humedoors.com.au

Port Macquarie Branch

No.2 Belah Road, Port Macquarie
NSW 2444
P | 02 6581 0011
E | pmsales@humedoors.com.au

Newcastle Branch

5 Hartley Drive, Thornton, NSW 2322
P | 02 4966 8880
E | nclsales@humedoors.com.au

VICTORIA



HUME DOORS & TIMBER (VIC) PTY LTD

ABN 87 006 329 906

33 Remington Drive, South Dandenong VIC 3175
PO Box 4236, South Dandenong VIC 3164
P | 03 9799 6888
E | hdtvic@humedoors.com.au

Tasmanian Branch

5 Hudson Fysh Drive, Western Junction
Tasmania 7212
PO Box 393, Prospect Tasmania 7250
P | 03 6774 9100
E | tassales@humedoors.com.au

SOUTH AUSTRALIA



HUME DOORS & TIMBER (SA) PTY LTD

ABN 34 007 512 209

89 Heaslip Road, Burton SA 5110
PO Box 2037, Salisbury Downs SA 5108
P | 08 8280 2000
E | hdtisa@humedoors.com.au

WESTERN AUSTRALIA



HUME DOORS & TIMBER (WA) PTY LTD

ABN 62 009 421 569

75 Briggs Street, Carlisle WA 6101
PO Box 118, Welshpool WA 6986
P | 08 9470 1800
E | hdtwa@humedoors.com.au

"Disclaimer: Hume Doors & Timber reserves the right to alter or amend without prior notice, any data, dimensions and design details specified herein. Photographs or illustrations may not depict the exact design or specification and may vary to the actual product. Timber is a natural material and colour, texture and grain variation can occur. These are not considered defects. Timber products are supplied unfinished unless otherwise specified."